

Maximum flexibility

Modular Counter Hot



The Fri-Jado Modular Counter range delivers a speedy and easy shopping experience for both customers and operators, through:

- A well-lit, clean and inviting hot, cold and ambient food system to cover all fresh food categories
- An ergonomic design providing easy access
- Unobstructed visibility for the customer
- Easy to adapt to any format within new stores or retrofits
- Providing the opportunity for increased basket sales through meal deals

Features MC Hot Square

Top features

- Inline heated display cabinet, full-serve or self-serve
- Can be combined with refrigerated and ambient counters
- Available in 1000 and 750 mm width

Standard characteristics

- Product temperature maintained at 65°C
- Combination of hot air and heated shelving: ensures heat consistency
- Air circulation per shelf that holds temperature effectively
- Lighting on each shelf
- Thermo pane glass-increased insulation
- Double glass sliding doors for optimal operator access
- Stainless steel and powder-coated interior and exterior
- Ideal for hot rolls, pies, pastries, chicken portions and other meal solutions
- Point-of-sales promotion options in price strips



POS options



MC 100 Cold Square



Three presentation levels

	MC 75 square hot FS	MC 75 square hot SS	MC 100 square hot FS	MC 100 square hot SS
Width	750 mm	750 mm	1000 mm	1000 mm
Depth	770 mm	770 mm	770 mm	770 mm
Height	1516 mm	1516 mm	1516 mm	1516 mm
Net weight	164 kg	158 kg	184 kg	177 kg
Gross weight	191 kg	184 kg	216 kg	208 kg
Voltage	1~230V	1~230V	1~230V	1~230V
Frequency	50 Hz	50 Hz	50 Hz	50 Hz
Power	2.8 kW	2.9 kW	2.8 kW	3.0 kW

MC 75 Hot Square

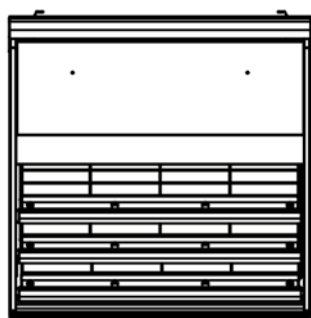

750

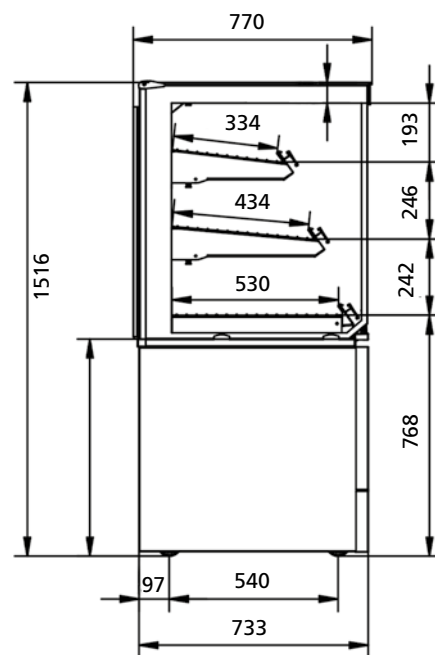
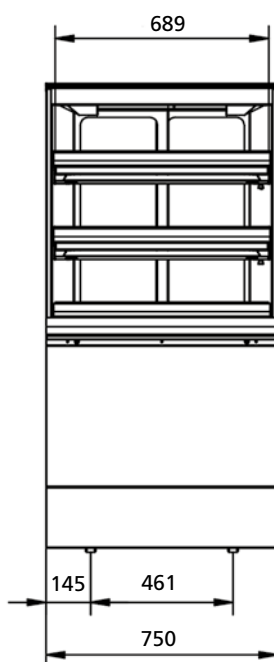

MC 100 Hot Square

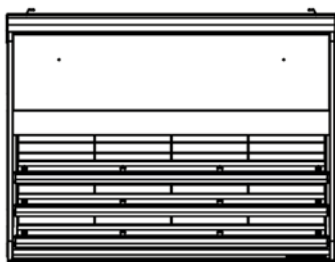

1000

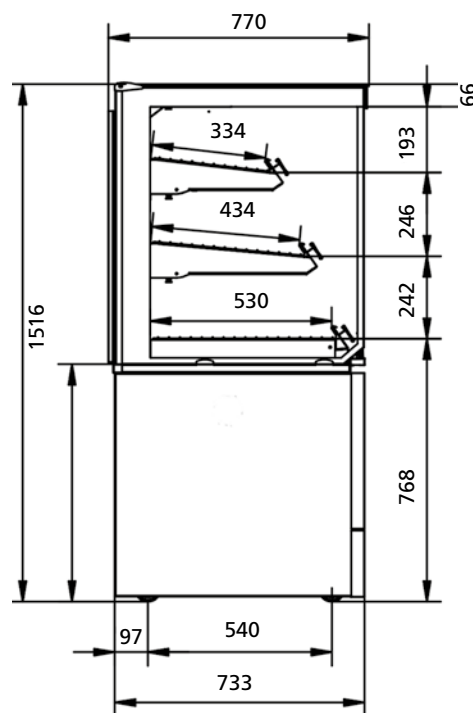
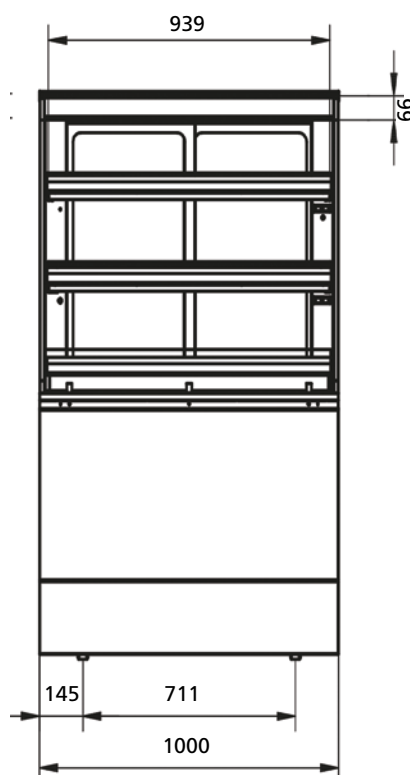

Specifications and technical data are subject to amendment without prior notice.

These are basic drawings. For more detailed technical information, please refer to the installation manual at www.frijado.com.

Fri-Jado B.V.
P.O. Box 560

4870 AN Etten-Leur
The Netherlands

Phone +31 76 50 85 400

Fax +31 76 50 85 444

e-mail info@frijado.com

www.frijado.com

Maximum flexibility

Modular Counter
Cold



The Fri-Jado Modular Counter range delivers a speedy and easy shopping experience for both customers and operators, through:

- A well-lit, clean and inviting hot, cold and ambient food system to cover all fresh food categories
- An ergonomic design providing easy access
- Unobstructed visibility for the customer
- Easy to adapt to any format within new stores or retrofits
- Providing the opportunity for increased basket sales through meal deals

Features MC Cold Square

Top features

- Inline refrigerated display cabinet, full-serve or self-serve
- Can be combined with hot and ambient counters
- Available in 1000 and 750 mm width

Standard characteristics

- Product temperature maintained at between 5°C and 7°C
- Air circulation per shelf that holds temperature effectively
- Lighting on each shelf
- Thermo pane glass-increased insulation
- Double glass sliding doors for optimal operator access
- Stainless steel and powder-coated interior and exterior
- Ideal for sandwiches, rolls, dairy products and other meal solutions
- Point-of-sales promotion options in price strips



POS options



MC 100 Hot Square



Three presentation levels

	MC 75 square cold FS	MC 75 square cold SS	MC 100 square cold FS	MC 100 square cold SS
Width	750 mm	750 mm	1000 mm	1000 mm
Depth	770 mm	770 mm	770 mm	770 mm
Height	1516 mm	1516 mm	1516 mm	1516 mm
Net weight	164 kg	165 kg	194 kg	187 kg
Gross weight	191 kg	192 kg	228 kg	220 kg
Temperature class	3M2	3M2	3M2	3M2
Voltage	1~230V	1~230V	1~230V	1~230V
Frequency	50Hz	50 Hz	50 Hz	50 Hz
Power	1,3 kW	1,3 kW	1,3 kW	1,3 kW

MC 75 Cold Square

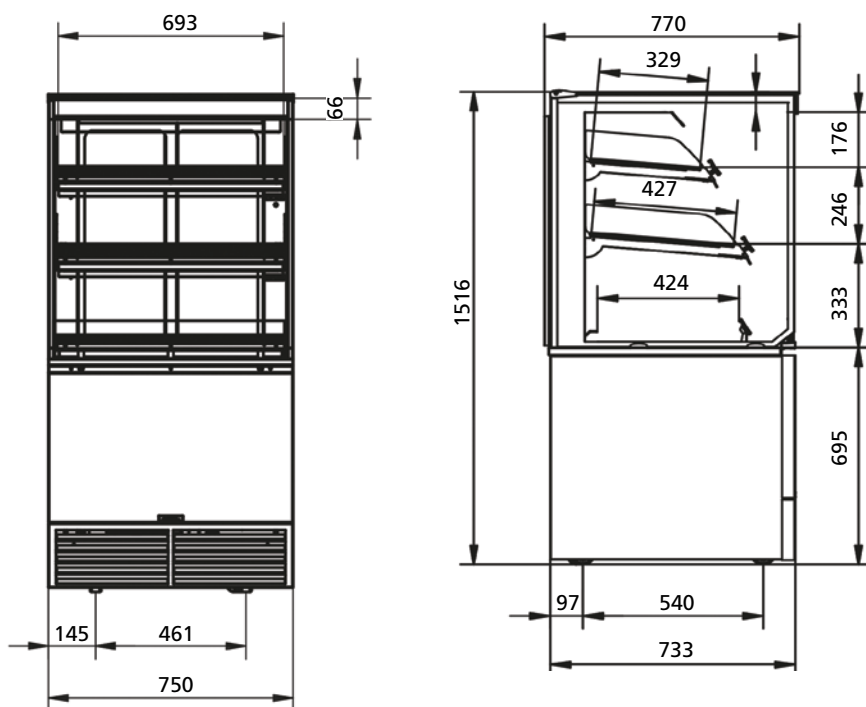

MC 100 Cold Square

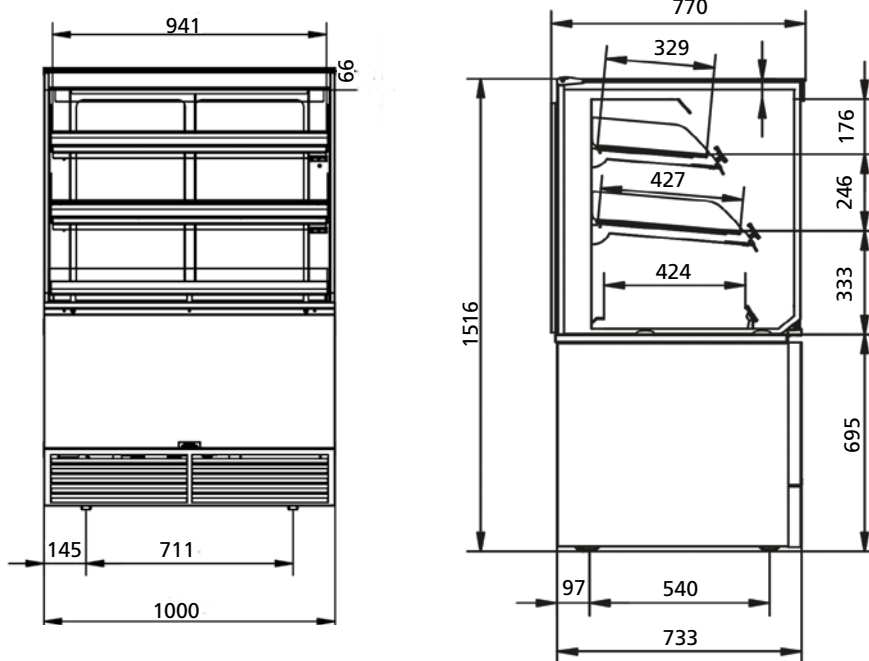
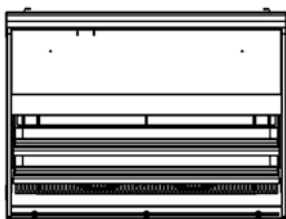

Specifications and technical data are subject to amendment without prior notice.

These are basic drawings. For more detailed technical information, please refer to the installation manual at www.frijado.com.

Fri-Jado B.V.

P.O. Box 560

4870 AN Etten-Leur

The Netherlands

Phone +31 76 50 85 400

Fax +31 76 50 85 444

e-mail info@frijado.com

www.frijado.com

Maximum flexibility

Modular Counter Ambient



The Fri-Jado Modular Counter range delivers a speedy and easy shopping experience for both customers and operators, through:

- A well-lit, clean and inviting hot, cold and ambient food system to cover all fresh food categories
- An ergonomic design providing easy access
- Unobstructed visibility for the customer
- Easy to adapt to any format within new stores or retrofits
- Providing the opportunity for increased basket sales through meal deals

Features MC Ambient Square

Top features

- Inline refrigerated display cabinet, full-serve or self-serve
- Can be combined with heated and refrigerated counters
- Available in 1000 and 750 mm width

Standard characteristics

- Lighting on each shelf
- Double glass sliding doors for optimal operator access
- Stainless steel and powder-coated interior and exterior
- Ideal for cakes, doughnuts, muffins, pies and other meal solutions
- Point-of-sales promotion options in price strips



POS options



MC 100 Hot Square



Three presentation levels

	MC 75 ambient FS	MC 75 ambient SS	MC 100 ambient FS	MC 100 ambient SS
Width	750 mm	750 mm	1000 mm	1000 mm
Depth	770 mm	770 mm	770 mm	770 mm
Height	1516 mm	1516 mm	1516 mm	1516 mm
Net weight	118 kg	112 kg	144 kg	137 kg
Gross weight	141 kg	134 kg	172 kg	165 kg
Voltage	1~230V	1~230V	1~230V	1~230V
Frequency	50Hz	50 Hz	50 Hz	50 Hz
Power	0,5 kW	0,5 kW	0,5 kW	0,5 kW

MC 75 Ambient Square

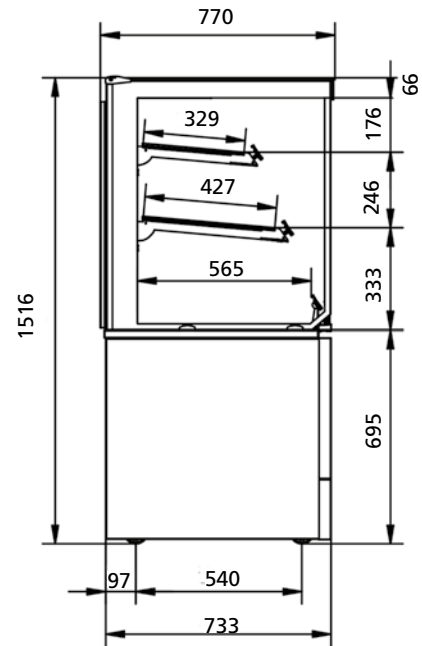
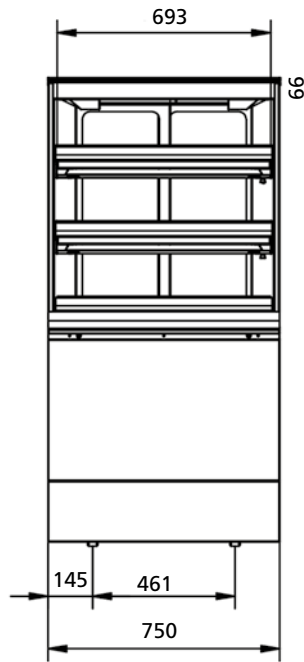

MC 100 Ambient Square

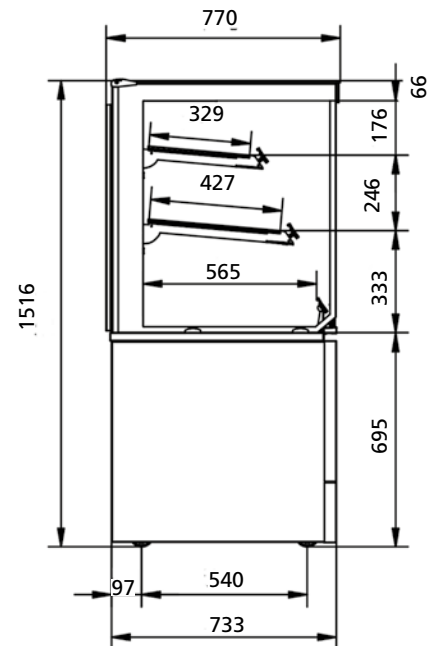
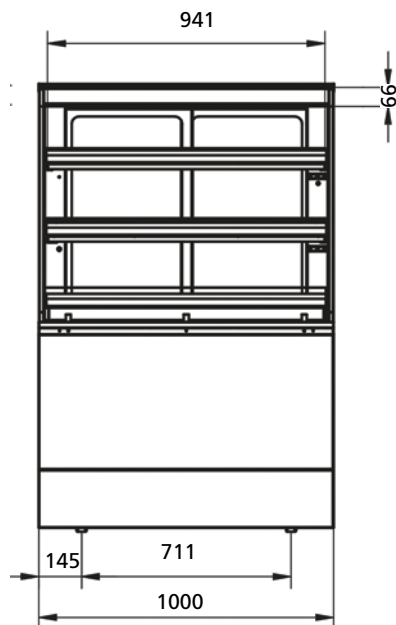
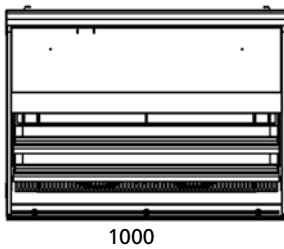

Specifications and technical data are subject to amendment without prior notice.

These are basic drawings. For more detailed technical information, please refer to the installation manual at www.frijado.com.

Fri-Jado B.V.

P.O. Box 560

4870 AN Etten-Leur

The Netherlands

Phone +31 76 50 85 400

Fax +31 76 50 85 444

e-mail info@frijado.com

www.frijado.com